

DESOLDERING TOOL

FR-400

Instruction Manual



Thank you for purchasing the HAKKO FR-400 Desoldering Tool.
Please read this manual before operating the HAKKO FR-400.
Keep this manual readily accessible for reference.



Table of Contents

1. PACKING LIST AND PART NAMES	1
2. SPECIFICATIONS	1
3. WARNINGS, CAUTIONS AND NOTES	2
4. INITIAL SETUP	3
5. OPERATION	5
6. PARAMETER SETTING	13
7. MAINTENANCE	22
8. CHECKING PROCEDURE	27
9. ERROR MESSAGE	29
10. TROUBLE SHOOTING GUIDE	30
11. PARTS LIST	31
12. WIRING DIAGRAM	34

1. PACKING LIST AND PART NAMES

Please check to make sure that all items listed below are included in the package.

HAKKO FR-400 Desoldering station	1	HAKKO FH-400 Handpiece holder	1
HAKKO FR-4003 Desoldering Handpiece (with N60-02 (ø1.0mm [0.04 in]) nozzle)	1	Toolbox	1
Power cord	1	Instruction Manual	1

Nozzle (N60 series)

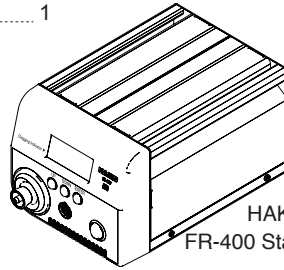
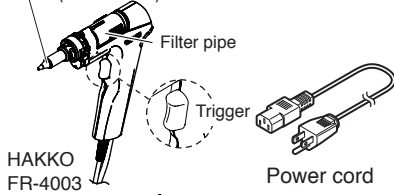

HAKKO
FR-400 Station

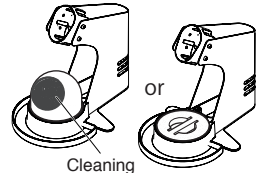

HAKKO FH-400
Handpiece holder

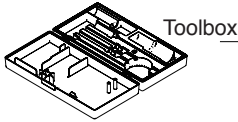

Toolbox

×4
Ceramic paper Filter
(Desoldering handpiece)

×2
Station
Filter

×1
Cleaning Pin (for ø1.0mm
[0.04 in] nozzle)

×1
Cleaning Drill (for ø1.0mm
[0.04 in] nozzle)

×1
Cleaning Pin
(for Heating Element)

×1
Nozzle wrench

2. SPECIFICATIONS

● HAKKO FR-400

Power consumption	320W
Temperature range	350 - 500°C (660 - 940°F)
Temperature stability	± 5°C (9°F) at idle temperature

● Station

Output	AC 29V
Vacuum generator	Vacuum pump, double cylinder type
Vacuum pressure (max.)	80 kPa (600 mmHg)
Suction flow	15L/min.
Dimensions	166(W)×137(H)×264(D) mm (6.5 × 5.4 × 10.4 in.)
Weight	5.7 kg (12.6 lb.)

● HAKKO FR-4003

Part name	HAKKO FR-4003
Power consumption	300W (29 V)
Nozzle to ground resistance	< 2 Ω
Nozzle to ground potential	< 2 mV
Cord	1.2 m (4 ft.)
Length (w/o cord)	183 mm (7.2 in.) with N60-02 nozzle
Weight (w/o cord)	270 g (0.6 lb.) with N60-02 nozzle

- * The temperature was measured using the HAKKO FG-101 Station Tester.
- * This product is protected against electrostatic discharge.
- * Specifications and design are subject to change without notice.

⚠ CAUTION

This product includes such features as electrically conductive plastic parts and grounding of the handpiece and station as measures to protect the device to be soldered from the effects of static electricity. Be sure to observe the following instructions:

1. The handle and other plastic parts are not insulators, they are conductors. When replacing parts or repairing, take sufficient care not to expose live electrical parts or damage insulation materials.
2. Be sure to ground the unit during use.

3. WARNINGS, CAUTIONS AND NOTES

Warnings, cautions and notes are placed at critical points in this manual to direct the operator's attention to significant items. They are defined as follows:

 **WARNING** : Failure to comply with a WARNING may result in serious injury or death.

 **CAUTION** : Failure to comply with a CAUTION may result in injury to the operator, or damage to the items involved.

NOTE : A NOTE indicates a procedure or point that is important to the process being described.

WARNING

When power is ON, the nozzle will be hot. To avoid injury or damage to personnel and items in the work area, observe the following:

- Do not touch the nozzle or the metal parts near the nozzle.
- Do not allow the nozzle to come close to, or touch, flammable materials.
- Inform others in the area that the unit is hot and should not be touched.
- Turn the power off when not in use, or left unattended.
- Turn the power off when connecting the HAKKO FR-4001 or storing the HAKKO FM-400.
- The unit is for a counter or workbench use only.
- This appliance is not intended for use by persons (including children) with reduced physical, sensory or mental capabilities, or lack of experience and knowledge, unless they have been given supervision or instruction concerning use of the appliance by a person responsible for their safety.
- Children should be supervised to ensure that they do not play with the appliance.

To prevent accidents or damage to the HAKKO FR-400, be sure to observe the following:

CAUTION

- Do not use the unit for applications other than desoldering.
- Do not strike the handpiece against hard objects to remove excess solder. This will damage the handpiece.
- Do not modify the HAKKO FR-400.
- Use only genuine HAKKO replacement parts.
- Do not allow the HAKKO FR-400 to become wet, or use it when hands are wet.
- Be sure to hold the plug when inserting or removing the handpiece and power cords.
- Be sure the work area is well ventilated. Soldering produces smoke.
- Be sure the cooling fan at the rear of the station is unrestricted.
- While using the HAKKO FR-400, don't do anything which may cause bodily harm or physical damage.

4. INITIAL SETUP

A. Handpiece holder

Loosen the adjusting screws to change the angle of the handpiece receptacle as you like, then tighten the screws.

⚠ CAUTION

Increasing the angle of the handpiece receptacle will cause an increase in the handpiece temperature.

● **Setup the handpiece holder**

Following the instructions given in the illustration on the right, assemble the handpiece holder.

NOTE :

You can put nozzles that are not in use on the radial tray of the cleaner base.

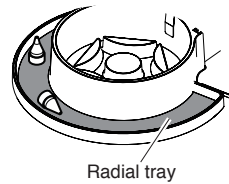
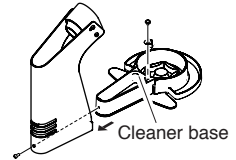
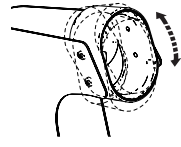

● **When the cleaning sponge is included in the PACKING LIST**

The sponge is compressed. It will swell when moistened with water. Before using the unit, dampen the sponge with water and squeeze it to remove excess water.

1. Fit the small sponge pieces into the hollows in the cleaner base.
2. Add an appropriate amount of water into the cleaner base. The small sponge pieces will absorb water and help keep the larger sponge damp at all times.
3. Dampen the large sponge, squeeze it to remove excess water and put it on the cleaner base.

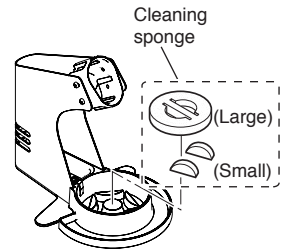

⚠ CAUTION

Be sure the sponge is moistened with water before use to avoid damaging the nozzle.

● **When the cleaning wire is included in the PACKING LIST**

Following the instructions given in the illustration on the right, put the cleaning wire on the cleaner base.

Operation:

First, remove any excess solder from the nozzle by thrusting the nozzle into the cleaning wire.

(Do not wipe the nozzle against the wire. This may cause molten solder to spatter.)

When the wire becomes dirty or loaded with solder, reposition the wire until a clean surface is presented. When changing the cleaning wire, lift the case top vertically to prevent solder debris from falling out.

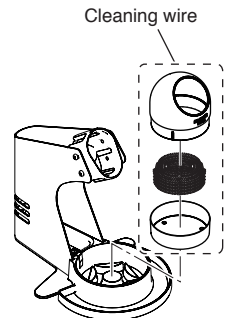

⚠ CAUTION

Be sure to hold the plug when inserting or removing the handpiece cord.

B. Station

● **Connection**

1. Connect the power cord to the receptacle on the rear of the station.
2. Connect the plug from the HAKKO FR-4003 to the receptacle on the HAKKO FR-400.

⚠ CAUTION

Connect the plug to the receptacle, aligning the tab on the plug with the opening on the receptacle.

3. Set the HAKKO FR-4003 in the handpiece holder.
4. Connect the hose from the HAKKO FR-4003 to the vacuum outlet cap on the HAKKO FR-400 station.
5. Plug the power cord into a grounded power outlet. Ensure that the power switch is OFF before plugging in the AC plug.

⚠ CAUTION

Be sure to ground this product as it is ESD safe by design.

6. Turn the power switch ON.

Insert the plug into the receptacle until it seats.

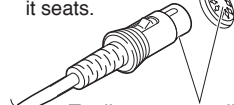

To disconnect, pull the plug from the receptacle while pressing down the tab on the plug.

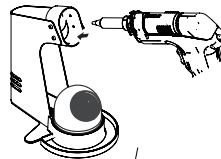

Connect the hose.

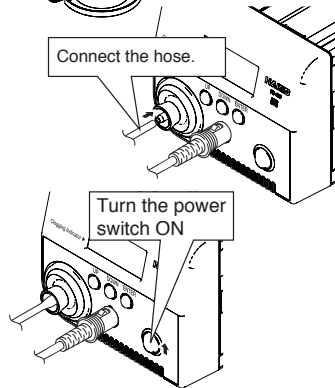

Turn the power switch ON

5. OPERATION

PART NAMES

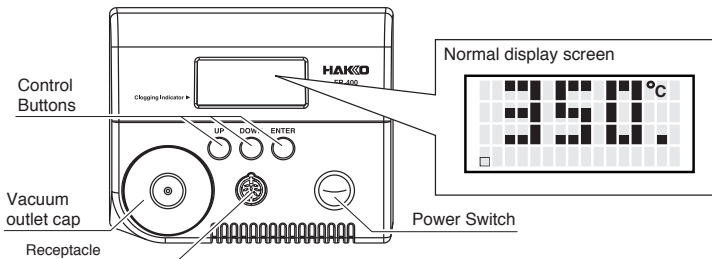

The HAKKO FR-400 has three controls

UP - Moving the cursor UP. Increases the value.

DOWN - Moving the cursor DOWN. Decreases the value.

ENTER - End of sequence (terminates a phase of a data entry mode).

A. Desoldering

⚠ CAUTION

If the pump does not operate, immediately clean the nozzle & heating element and replace the filter if necessary.

1. Place the nozzle over the lead wire of the part to be desoldered and begin heating.

Be careful to heat the lead wire and the solder, not the land. Placing the nozzle directly in contact with the land may cause the land to peel off. You may apply a small amount of solder to form a heat bridge to help the heating process.

2. Check to make sure all of the solder on the joint has melted.

With the nozzle still in place over the lead wire, slowly move the lead wire, being careful not to apply too much force. If the lead wire moves easily, all of the solder has melted.

3. Pull the trigger to remove the melted solder.

Make sure that a filter has been inserted in the desoldering tool. Desoldering without a filter may damage the pump.

4. If the solder was not removed, re-solder the part using new solder and then repeat the desoldering process.

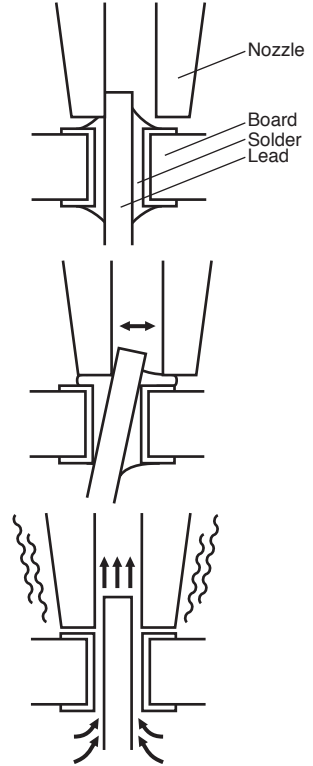

● When triggering before the heater reaches set temperature

When triggering before the heater reaches set temperature, the display screen shows "HEATING PLEASE WAIT" and the vacuum does not work. Please wait for the heater to reach the set temperature.

HEATING . . .
PLEASE WAIT

B. Making Changes to Settings

● Selecting the preset number

The HAKKO FR-400 has a preset mode.

1. Press any of the three control buttons.

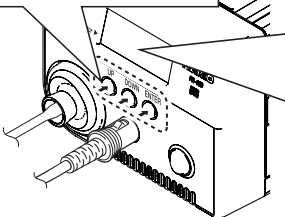

2. The preset selection screen appears.

▶PRESET1	350°C	
PRESET2	400°C	
PRESET3	450°C	
<↑>	<↓>	<ENT>

If you wish to exit the PRESET SELECTION screen, simply use the DOWN button to scroll to the bottom of the list, and select <EXIT>.

3. Make your SELECTION by moving the cursor UP or DOWN by pressing the corresponding buttons.

▶PRESET1	350°C
PRESET2	400°C
PRESET3	450°C
<↑>	<↓>
<ENT>	

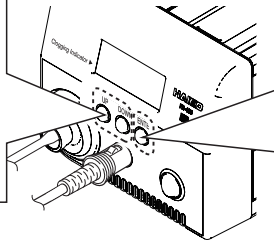

4. Press the <ENT> button to finalize your selection.

▶PRESET1	350°C
PRESET2	400°C
PRESET3	450°C
<↑>	<↓>
<ENT>	

If you wish to exit the PRESET SELECTION screen...

- You select <EXIT> and press the <ENT> button, you will return to the normal display without making change.
- if the device is left alone without making any operation for 10 seconds, you will return to the normal display.

When changing the current set temperature or the preset temperature, follow the operation of “● Changing various setting (other than preset selections)”.

● Changing various settings (other than preset selections)

1. Press and hold any one of the three control buttons for at least 2 seconds.

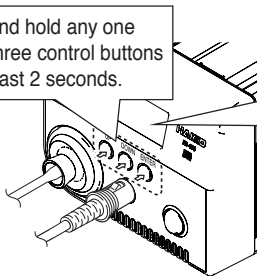

2. The setting selection screen appears.

▶Set Temp	
Offset Temp	
Vacuum Check	
<↑>	<↓>
<ENT>	

The following settings can be changed from this screen:

- Set Temp (Nozzle temperature setting)
- Offset Temp (Nozzle temperature offset setting)
- Vacuum Check (Check of nozzle clogging and suction force)
- Preset Temp (Setting of each preset temperature)
- Preset ID (Setting of each preset name)
- LCD Contrast (Contrast adjustment of display screen)
- <EXIT> (Return to the setting screen)

3. Make your SELECTION by moving the cursor UP or DOWN by pressing the corresponding buttons.

▶Set Temp	
Offset Temp	
Vacuum Check	
<↑>	<↓>
<ENT>	

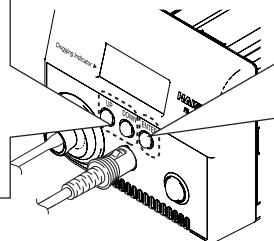

4. Press the <ENT> button to finalize your selection.

▶Set Temp	
Offset Temp	
Vacuum Check	
<↑>	<↓>
<ENT>	

● Set Temp

⚠ CAUTION

The temperature range is from 350 to 500°C. (660 to 940°F)

- If you enter a value outside the temperature setting range, the display returns to the hundreds digit, and you have to enter a correct value.

1. Move the cursor to select "Set Temp". After selecting, press <OK>.

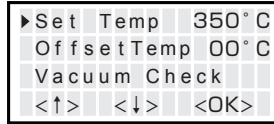

2. Entering from hundreds to units digit
Press the <↑> or <↓> to set the desired figure.

Only values from 3 to 5 can be selected when entering the hundreds digit.

(In °F mode, values from 6 to 9 can be selected.)

Values from 0 to 9 can be selected when entering the tens or units digits.

(The same values can be selected in °F mode.)

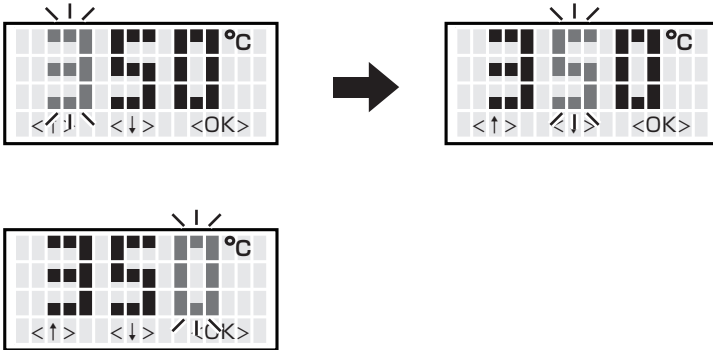

3. When desired figure is displayed, press the button to enter.

The next digit will begin to flash. After entering the units digit, press the button to save the figure to the system memory and begin heater control with new setting temperature.

⚠ CAUTION

If power is switched off or lost during the execution of this procedure, no data will be entered. The entire procedure must be repeated from step 1.

● Offset Temp

Example : If the measured temperature is 405°C and set temperature is 400°C, the difference is -5°C. (need to decrease by 5°C) So, enter the figure which 5 is deducted from present offset value.

1. Move the cursor to select "Offset Temp". After selecting, press <OK>.

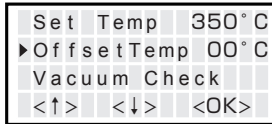

2. Enter the offset value (-5) which is the difference between tip temperature and set temperature.

The hundreds digit can display 0 (for positive value) or minus sign. (for negative value)
(Same values can be selected in °F mode.)

Values from 0 to 5 can be selected when entering the ten digit.

(In °F mode, values from 0 to 9 can be selected.)

Values from 0 to 9 can be selected when entering the units digit.

(Same values can be selected in °F mode.)

The allowable ranges for offset values are from -50 to +50°C . (In °F mode, from -90 to +90°F) If you enter a value outside the offset value range, the display returns to the hundreds digit, and you have to enter a correct value.

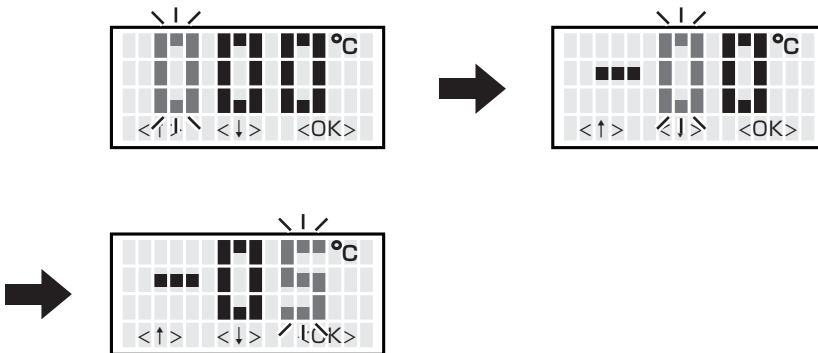

3. After entering the units digit, press the button to save the figure to the system memory and begin heater control with the new offset value.

⚠ CAUTION

During the offset setting, please be careful tip temperature does not exceed 500 °C.

● Vacuum Check

During suction, the gauge indicating sucking status is shown at the lower side of the screen.

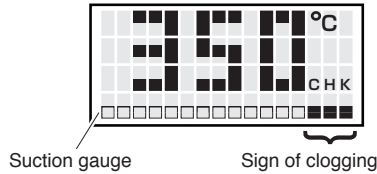

When “CHK” appears and you notice that the sucking force is weakening, perform “Vacuum Check.”

1. Move the cursor to select “Vacuum Check”. After selecting, press <OK>.

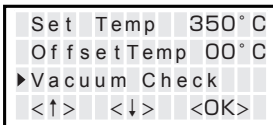

2. Pull the trigger.

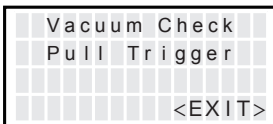

3. When “Clogging” appears, perform cleaning and replace filters.

No degradation in sucking force

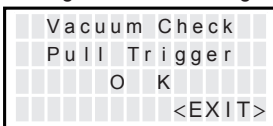

Degradation in sucking force

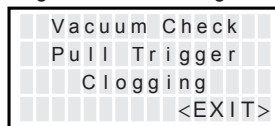

● Preset Temp

⚠ CAUTION

The temperature range is from 350 to 500°C. (660 to 940°F)

- If you enter a value outside the temperature setting range, the display returns to the hundreds digit, and you have to enter a correct value.

1. Move the cursor to select “Preset Temp”. After selecting, press <OK>. Select the preset No. whose temperature setting you wish to change.

OffsetTemp	00° C
Vacuum Check	
▶Preset Temp	
<↑>	<↓>
	<OK>



Select the preset No.

▶P1 Temp	350° C
P2 Temp	400° C
P3 Temp	450° C
<↑>	<↓>
	<OK>

2. Entering from hundreds to units digit
Press the <↑> or <↓> to set the desired figure.

Only values from 3 to 5 can be selected when entering the hundreds digit.

(In °F mode, values from 6 to 9 can be selected.)

Values from 0 to 9 can be selected when entering the tens or units digits.

(The same values can be selected in °F mode.)

PRESET1	TempSet
	350° C
<↑>	<↓>
	<OK>



PRESET1	TempSet
	350° C
<↑>	<↓>
	<OK>



PRESET1	TempSet
	350° C
<↑>	<↓>
	<OK>

3. After entering the units digit, press the button to save the figure to the system memory and begin heater control with new setting temperature.

⚠ CAUTION

If power is switched off or lost during the execution of this procedure, no data will be entered. The entire procedure must be repeated from step 1.

4. To exit from each setting screen, scroll the screen, select <Exit>, and press the <OK> button.

P2 Temp	400° C
P3 Temp	450° C
▶<EXIT>	
<↑>	<↓>
	<OK>

● Preset ID

CAUTION

As a preset ID, 1 to 8 characters can be used.
Usable characters are “A-Z,” “0-9,” and space (“ ”). Entering a space makes your entry terminated. Any character(s) that follows the space is deleted.

1. Move the cursor to select “Preset ID”. After selecting, press <OK>.

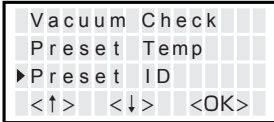

2. Move up and down the cursor with the control buttons.
After selecting, press <OK>.

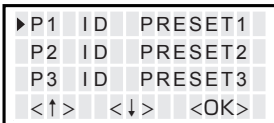

3. Press the <↑> or <↓> to set the desired letters.

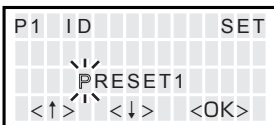

4. To exit from setting screen, scroll the screen, select <Exit>, and press the <OK> button.

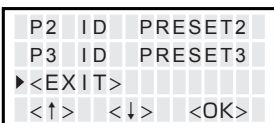

● LCD Contrast

To make the screen display easy to see, adjust contrast.

1. Move the cursor to select "LCD Contrast". After selecting, press <OK>.

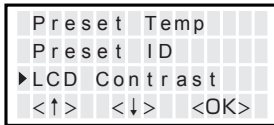

2. Press the <↑> or <↓> to set the adjust contrast.
(Selection range is 1 to 25.)

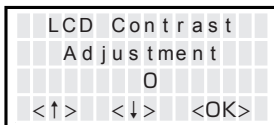

3. Press the <OK> button to set the value.

To exit from each setting screen, scroll the screen, select <Exit>, and press the <OK> button.

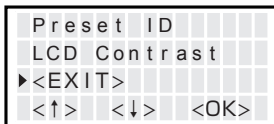

6. PARAMETER SETTING

● PARAMETER SETTINGS

Press and hold any one of the three control buttons, and turn on the power switch to display the parameter setting screen. The following parameters can be set:

Parameter name	Value	Initial value
Temp Mode	°C / °F	°C (°F*)
ShutOff Set	OFF / ON	OFF
Timer**	30 ~ 60 min	30 min
Vacuum Mode	Normal / Timer	Normal
Vacuum Time***	1~5sec	1sec
AutoSleep	OFF / 1 ~ 29min	6 min
Sleep Temp	200 ~ 300°C (390 ~ 570 °F)	200°C (390°F)
Low Temp	30 ~ 150°C (54 ~ 270°F)	150°C (270°F)
Error Alarm	ON / OFF	ON
Ready Alarm	ON / OFF	ON
Pass. Lock	ON (Lock/Partial) / OFF (unlock)	OFF
Password****	"ABCDEF" Select three letters	-
Initial Reset	°C / °F / Cancel	

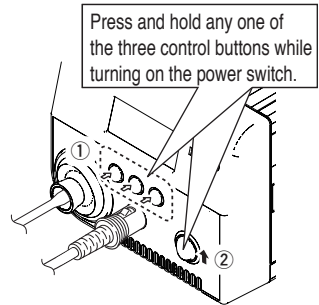

* For USA.

** Auto-shutOff Time can be set when Auto-ShutOff is set to ON.

*** Vacuum Time is displayed when Vacuum Mode is set to "Timer."

****Password is displayed when Password Lock is set to "ON" or "Partial."

※ 各言語（日本語、英語、中国語、フランス語、ドイツ語、韓国語）の取扱説明書は以下のURL、HAKKO Document Portalからダウンロードしてご覧いただけます。

（商品によっては設定の無い言語がありますが、ご了承ください）

* 各國語言(日語,英語,中文,法語,德語,韓語)的使用說明書可以通過以下網站的HAKKO Document Portal 下載參閱。
(有一部分的產品沒有設定外語對應,請見諒)

* Instruction manual for the language, Japanese, English, Chinese, French, German and Korean can be downloaded from the following URL, HAKKO Document Portal.
(Please note that some language may not be available depending on the product.)



<https://doc.hakko.com>

● Temp Mode

The displayed temperature can be switched between Celsius and Fahrenheit.

1. Move the cursor to select "Temp Mode".

After selecting, press <OK>.

▶Temp Mode	°C	
ShutOff Set	OFF	
Vacuum Mode	NOR	
<↑>	<↓>	<OK>

2. °C and °F will be switched alternately if you press the <↑> or <↓> button.

Temp Mode Set	°C	
	°F	
<↑>	<↓>	<OK>

3. Return to parameter setting display if you press the <OK> button after setting.

● ShutOff Set

Select whether you will activate the auto shut off function. When the auto shutoff function is set to on and no operation is performed for constant time after the iron is set in the iron holder, the buzzer sounds three times and the auto shutoff function will be enabled.

1. Move the cursor to select "ShutOff Set".

After selecting, press <OK>.

Temp Mode	°C	
▶ShutOff Set	OFF	
Vacuum Mode	NOR	
<↑>	<↓>	<OK>

2. ON and OFF will be switched alternately if you press the <↑> or <↓> button.

Shut Off Set	OFF	
Shut Off	OFF	
Timer	30m	
<↑>	<↓>	<OK>

3. Selecting "ON" allows you to make the setting for "Timer."
(Default is 30 minutes.)

(Next page)

● **ShutOff Set**

4. When setting “Shut Off” to “ON,” the area for “Timer” flashes.

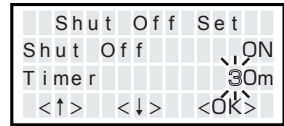

5. Press the <↑> or <↓> to set the desired figure.



6. Pressing the <OK> button after this change makes the set time stored in the internal memory.

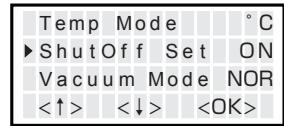

● Vacuum Mode

Select whether you manually operate the desoldering pump or use the timer function.

Normal : Solder is sucked only when you are pulling the trigger.

Timer : Even after you release the trigger, sucking continues for the specified period of time.

* Set time in "Vacuum Time."

1. Move the cursor to select "VacuumMode".
After selecting, press <OK>.

2. Normal and Timer will be switched alternately
if you press the <↑> or <↓> button.

3. Return to parameter setting display
if you press the <OK> button after
setting.

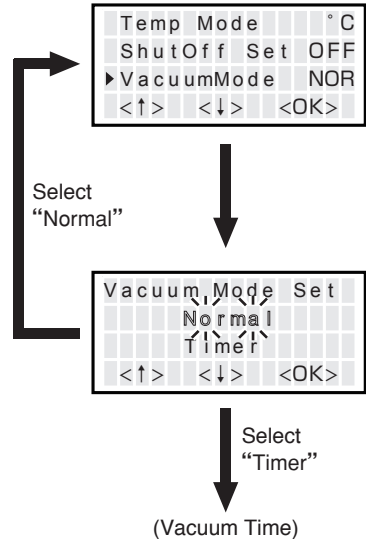

* When selecting Timer:

"Vacuum Time" appears under "Vacuum Mode" in the parameter select screen.

● Vacuum Time

1. Move the cursor to select "Vacuum Time".
After selecting, press <OK>.

2. Press the <↑> or <↓> button, you can
change to the desired value.

3. Return to parameter setting display
if you press the <OK> button after
setting.

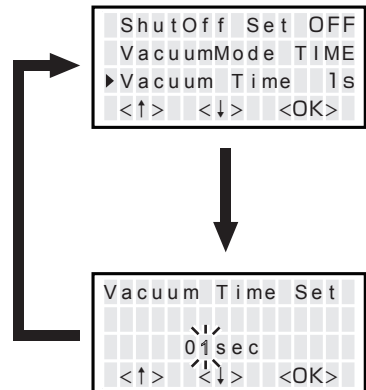

● Auto Sleep

Select whether you will activate the auto sleep function. When the auto sleep function is set to on and no operation is performed for constant time after the iron is set in the iron holder, the auto sleep function will be enabled.

* Set temp in "Sleep temp".

1. Move the cursor to select "Auto Sleep".
After selecting, press <OK>.

ShutOff	Set	OFF
VacuumMode		NOR
▶Auto	Sleep	OFF
<↑>	<↓>	<OK>

2. ON and OFF will be switched alternately if you press the <↑> or <↓> button.



Auto	Sleep	Set
Auto	Sleep	OFF
Timer		06m
<↑>	<↓>	<OK>

3. Selecting "ON" allows you to make the setting for "Timer."
(Default is 6 minutes.)

Select
"ON"

* When selecting "ON"

4. When setting "Auto Sleep" to "ON,"
the area for Timer flashes.

Auto	Sleep	Set
Auto	Sleep	ON
Timer		06m
<↑>	<↓>	<OK>

5. Press the <↑> or <↓> button, you can
change to the desired value.



ShutOff	Set	OFF
VacuumMode		NOR
▶Auto	Sleep	06m
<↑>	<↓>	<OK>

6. Pressing the <OK> button after this change
makes the set time stored in the internal
memory.

● Sleep Temp

Sets the auto sleep temperature.

1. Move the cursor to select "Sleep Temp".
After selecting, press <OK>.

2. Entering from hundreds to units digit.
Press the <↑> or <↓> to set the desired figure.

Only values from 2 to 3 can be selected when entering the hundreds digit.

(In °F mode, values from 3 to 5 can be selected.)

Values from 0 to 9 can be selected when entering the tens or units digits.

(The same values can be selected in °F mode.)

3. After entering the units digit, press the button to save the figure to the system memory

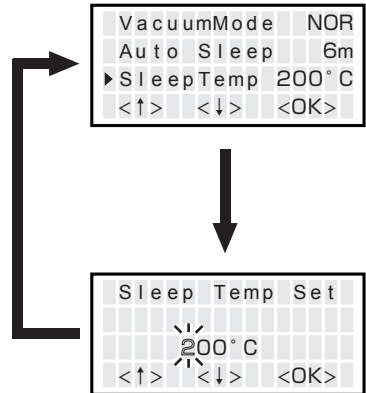

● Low Temp

When the temperature drops below a set limit, an error is displayed and the buzzer sounds.

1. Move the cursor to select "Low Temp".
After selecting, press <OK>.

2. Entering from hundreds to units digit.
Press the <↑> or <↓> to set the desired figure.

Only values from 0 to 1 can be selected when entering the hundreds digit.

(In °F mode, values from 0 to 2 can be selected.)

Values from 0 to 9 can be selected when entering the tens or units digits.

(The same values can be selected in °F mode.)

3. After entering the units digit, press the button to save the figure to the system memory

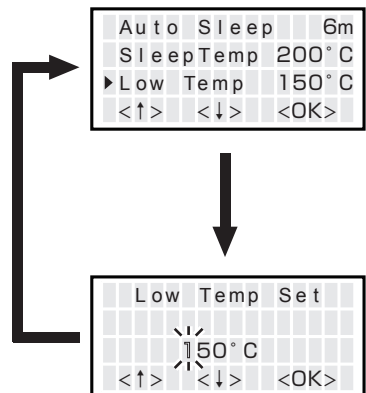

● Error Alarm

In the buzzer sound setting mode, which sets whether to sound the buzzer when a error occurs.

1. Move the cursor to select "Error Alarm".
After selecting, press <OK>.
2. ON and OFF will be switched alternately if you press the <↑> or <↓> button.
3. Return to parameter setting display if you press the <OK> button after setting.

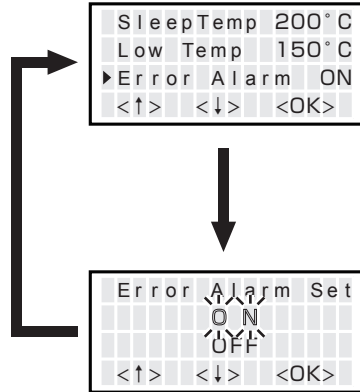

● Ready Alarm

When the set temperature alert setting mode is on, the buzzer sounds if you reached the usable temperature.

1. Move the cursor to select "Ready Alarm".
After selecting, press <OK>.
2. ON and OFF will be switched alternately if you press the <↑> or <↓> button.
3. Return to parameter setting display if you press the <OK> button after setting.

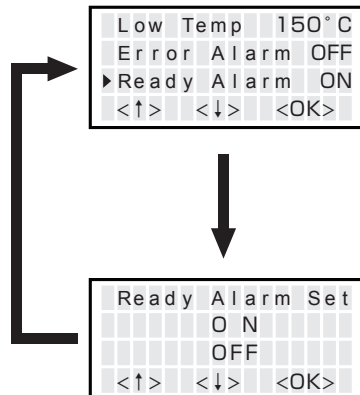

● Pass. Lock

When enabling this function, you must enter a correct password to change a setting. The options are as follows:

Lock : All setting changes require a password entry.

Partial : Selection of whether or not to enter a password when changing set temperature, preset selection, and offset temperature. All other setting changes require a password entry.

Unlock : Any setting change does not require a password entry.

1. Move the cursor to select "Pass. Lock".
After selecting, press <OK>.

2. Using the <↑> or <↓> button, select an option from Lock, Partial, and Unlock.

* When selecting Partial or Lock:

3. Specify whether password lock should be enabled when changing set temperature, preset selection, and offset temperature by selecting ON or OFF. (Only when selecting Partial)

4. After making all selections, press the <OK> button. (Only when selecting Partial)

5. Using the <↑> or <↓> button, enter a password. (Selection of three characters from ABCDEF)

6. Return to parameter setting display if you press the <OK> button after setting.

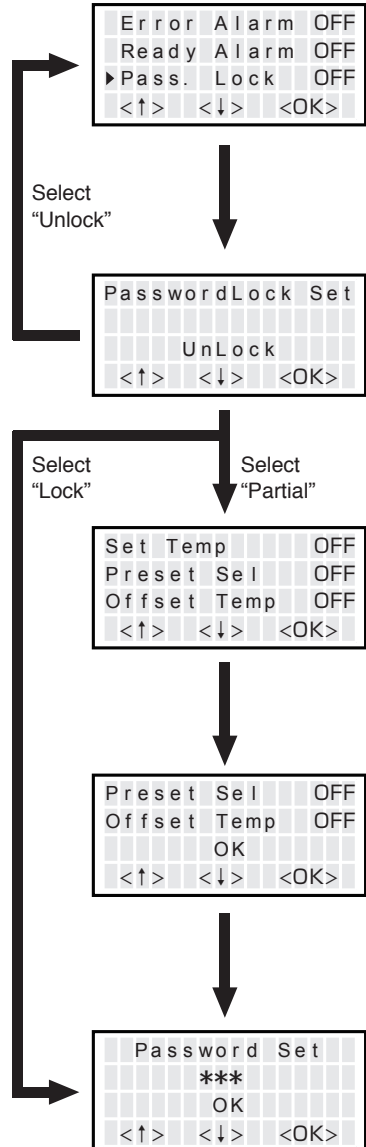

● Initial Reset

Initial Reset allows the factory default settings to be restored.

1. Move the cursor to select "Initial Reset".
After selecting, press <OK>.

2. Using the <↑> or <↓> button, select either C or F. To stop Initial Reset, scroll the screen to select <Exit>.

3. After selecting it, using the <↑> or <↓> button, select OK or Cancel.

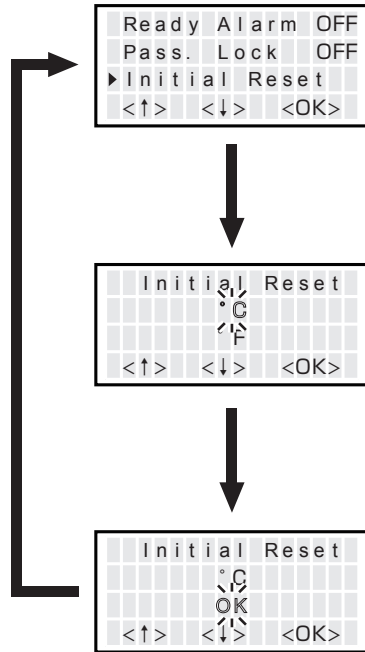

⚠ CAUTION

Even when Initial Reset is finished, "Pass. Lock" and password settings remain.

After completing settings, if you press the "OK" button again in the selection screen, you will return to the normal display.

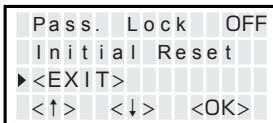

7. MAINTENANCE

Properly maintained, the HAKKO FR-400 desoldering tool should provide years of good service. Efficient desoldering depends upon the temperature, nozzle selection, and proper routine maintenance. Perform the following service procedures as dictated by the conditions of the station's usage.

▲WARNING

Since the desoldering tool can reach a very high temperature, please work carefully. Except when cleaning the nozzle and heating element, ALWAYS turn the power switch OFF and disconnect the power plug before performing any maintenance procedure.

During suction, the gauge indicating suction force is shown at the bottom of the screen.

If "CHK" appears on the display, check the nozzle and heater for restrictions.

If the nozzle or heater are clogged, clean or replace them.

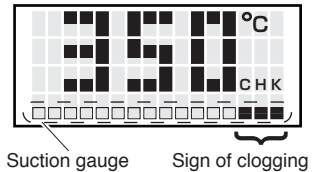

Replacing the filter

Replace the filter as shown following steps A to C. During operation, the filter pipe is very hot. Wait until the filter pipe is cool before replacing the filter or cleaning. We recommend keeping a second filter pipe containing new filters handy, and replacing the installed filter pipe with this secondary filter pipe.

C. Replace the entire filter pipe with a secondary filter pipe.

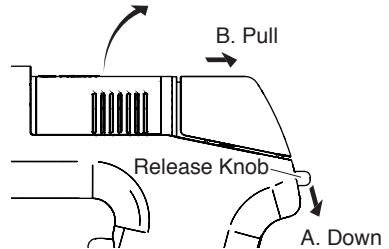

▲CAUTION

The section from the heating element to the filter pipe is provided with pipes through which melted solder passes, so it may become very hot. Be very careful when handling this section.

CAUTION : HOT AREA

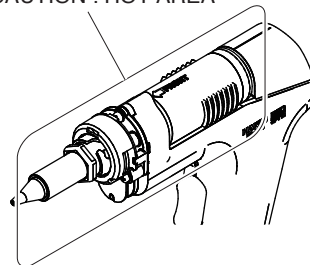

Nozzle Maintenance

⚠ CAUTION

The desoldering tool may be extremely hot. During maintenance, please work carefully.

1. Inspect and clean the nozzle

- Turn the power switch ON and let the nozzle heat up.

⚠ CAUTION

The cleaning pin will not pass through the nozzle until the solder inside the nozzle is completely melted.

- Clean out the hole of the nozzle with the nozzle cleaning pin.
- If the cleaning pin does not pass through the hole in the nozzle, clean with the cleaning drill.
- Check the condition of the solder plating on the nozzle tip.

⚠ CAUTION

If the cleaning drill is forced into the nozzle, the drill bit could break or be damaged. Please use the proper size cleaning pin or cleaning drill for the nozzle diameter.

- Check visually if the nozzle was eroded.

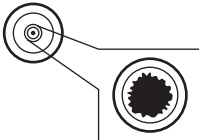

- If the cleaning pin and cleaning drill do not pass through the hole in the nozzle, replace the nozzle.
- If the solder plating on the nozzle tip is worn, replace the nozzle.
- If the inside hole of the nozzle is eroded, replace the nozzle.

Hole is damaged by erosion.

⚠ CAUTION

Desoldering efficiency goes down and all other parts appear to be OK, the nozzle is probably eroded and should be replaced.

The inside hole and the surface of the nozzle is plated with a special alloy. Should this alloy become eroded by high temperature solder, the nozzle will not be able to maintain the proper temperature.

- If the nozzle is still in a good condition, put some fresh solder on the nozzle tip to protect solder plated area from oxidation.

Cleaning with the nozzle cleaning pin

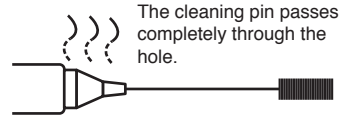

Cleaning with the cleaning drill

- Before cleaning

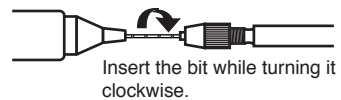

- After cleaning

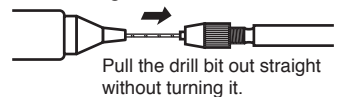

Use the proper size cleaning pin or cleaning drill for the nozzle diameter.



2. Disassemble the heating element.

Remove the enclosure pipe using the included nozzle wrench.



⚠ CAUTION

The heating element is very hot during operation.

Heating Element



Nozzle

Enclosure pipe

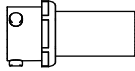

The enclosure pipe is held to the nozzle changing tool by pressing this part from both sides.

(The nozzle is not held to the nozzle changing tool. Be careful when removing them.)

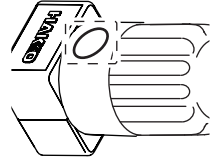

3. Clean out the tube in the heating element with the provided cleaning pin.

Scrape away all oxidation from the tube in the heating element until the cleaning pin passes cleanly through the tube.

- Turn the power off after cleaning.

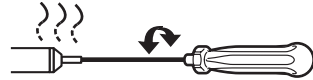

⚠ CAUTION

- Be sure the solder in the tube in the heating element is completely heated, before cleaning the tube.
- If the cleaning pin does not pass through the tube in the heating element, replace the heating element.

4. Replace the filters.

- When the filter pipe is cool to the touch, push down on the release knob at the back of the handpiece and remove the filter pipe.

⚠ CAUTION

The filter pipe is very hot.

- Examine the seals (front and filter holders) at each end of the filter pipe. Replace : Stiff and/or cracked.
- Examine the Pre-filter: Remove solder adhering to the waste collector.
- Examine the ceramic paper filter. Replace : Ceramic paper filter is showing signs of stains from flux, is stiff, or contains any solder.

Front holder

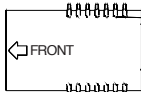

Pre-filter

Filter holder

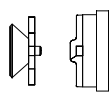

Ceramic paper filter



5. Replacement of station filter

If the filter is showing signs of stains from flux or is stiff, replace it. Attach the filter as shown in the right diagram.

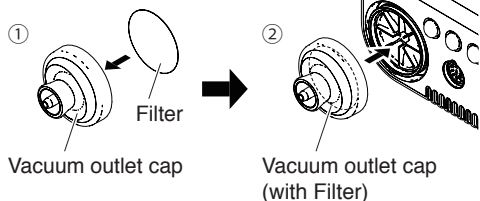

Replacing the heating element (heating core)

⚠ CAUTION

Except the case especially indicated, always turn the power switch OFF and disconnect the power plug before performing any maintenance procedure.

● Disassemble the heating element.

1. Remove the nozzle and enclosure pipe.

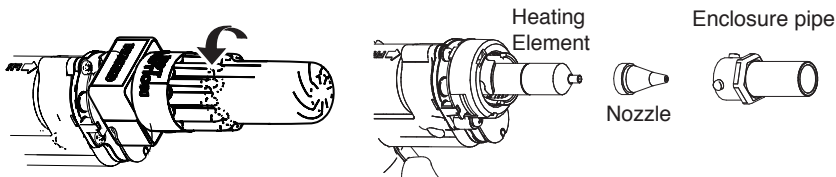

Remove the enclosure pipe and the nozzle with the attached wrench.

2. Remove the 3 screws from the handpiece and disconnect the heating element.

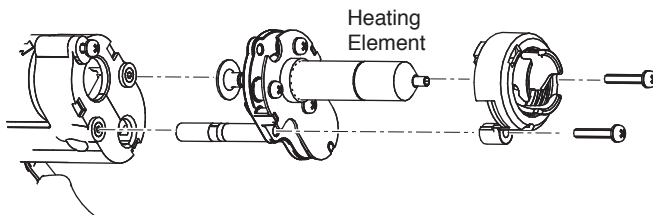

3. Replace the heating element. Assemble using the same procedure in reverse.

⚠ CAUTION

Be sure to calibrate the nozzle temperature after replacing the heating element. Failure to do this may result in a heater temperature that is much higher or lower than the previous one.

Maintenance of the pump head

● Remove the cover

When performing maintenance on the pump head, remove the screws holding the cover and take the cover off.

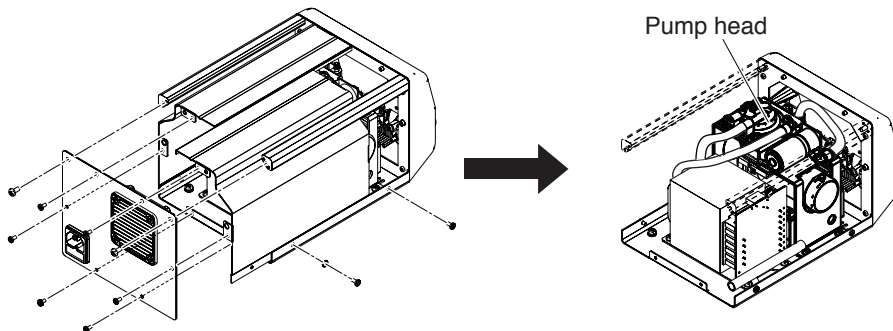

● Cleaning the pump head

1. Remove the valve and valve guard and remove any attached flux.

⚠ CAUTION

- When the valve guard is difficult to remove, please warm it with hot air. Please do not try to forcibly remove it with a screwdriver, etc. If the valve guard becomes deformed, it will no longer be airtight.
- Please clean with either alcohol or thinner.

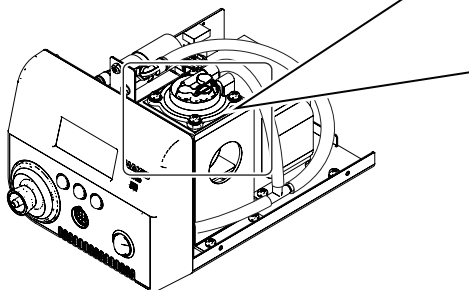

2. Install the valve and valve guard.

⚠ Caution

When assembling the pump, please make sure to keep it airtight so that there are no air leaks.

Pump head disassembly
*It is resting on its side.
Clean the pump head, valve
and valve guard.

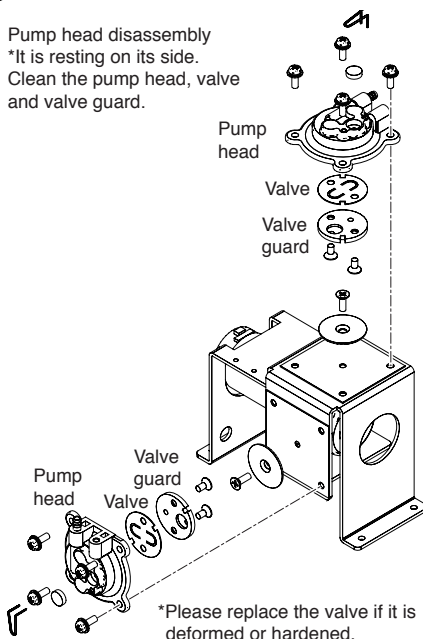

8. CHECKING PROCEDURE

WARNING

Unless otherwise directed, carry out these procedures with the power switch OFF and the power UNPLUGGED.

■ Check for a broken heater or sensor

1. Check for a broken heater or sensor

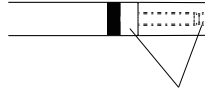

Measure the resistance across this position.

Verify the electrical integrity of the heater and sensor.

Measure the resistance of the heater and sensor while at room temperature (15~25°C ; 59~77°F) . It should be $3.4 \Omega \pm 10\%$. If the resistance exceeds these limits, replace the tip.

■ Replacing the fuse

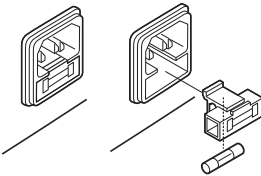

1. Unplug the power cord from the power receptacle.
2. Remove the fuse holder.
3. Replace the fuse.
4. Put the fuse holder back in place.

■ **Checking the connection cord for breakage**

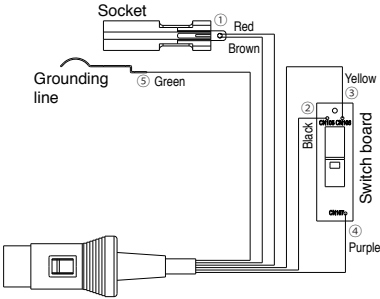
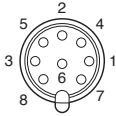

■ **Checking the grounding line**

Checking the connection cord for breakage

1. Unplug the connection cord from the station.
2. Disassemble the heating element. {Please refer to [Replacing the heating element (heating core)]}
3. Measure the resistance values between the connector and the lead wires at the socket as follows:

- Pin1 ······ Red (Socket) ①
- Pin2 ······ Green (Grounding line) ⑤*
- Pin3 ······ Black (Switch board) ②
- Pin5 ······ Yellow (Switch board) ③
- Pin6 ······ Purple (Switch board) ④
- Pin8 ······ Brown (Socket) ①

If any value exceeds 0Ω or is ∞ , replace the connection cord.

* For information on the plug 2, refer to “■ **Checking the grounding line**”

1. Measure the resistance value between Pin 2 and the nozzle.
2. If the value exceeds 2Ω (at room temperature), perform the nozzle maintenance. If the value still does not decrease, check the connection cord for breakage.

9. ERROR MESSAGE

● Sens Error

When there is the possibility that a failure has occurred in the sensor or heater (including the sensor circuit), "**Sens Error**" is displayed and the power is shut down.

● Grip Error

"**Grip Error**" will be displayed if the connector cord is not attached to the station OR the wrong soldering iron is connected.

● Low Temp Error

If the sensor temperature falls below the difference between the current temperature setting and the low-temperature alarm tolerance, "**Low Temp Error**" is displayed and the warning buzzer sounds. When the nozzle temperature rises to a value within the set tolerance, the buzzer will stop sounding.

EXAMPLE:

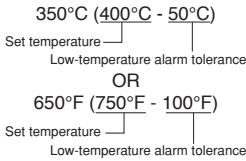

EXAMPLE:

Assume that the temperature setting is 400°C/750°F and the tolerance 50°C/100°F. If the temperature continues to decrease and finally falls below the value indicated while the heating element is on, "Low Temp Error" is displayed.

● Heater Short Error

"**Heater Short Error**" will flash, and the buzzer will sound continuously, when the nozzle is inserted incorrectly, an incompatible nozzle is inserted, or a foreign object has found its way into the connector.

● FATAL Error

This is displayed when the system is unable to operate normally. Should this error be displayed, please contact your HAKKO representative.

10. TROUBLE SHOOTING GUIDE

⚠ WARNING

Before checking the inside of the HAKKO FR-400 or replacing parts, be sure to disconnect the power plug. Failure to do so may result in electric shock.

● **Display does not turn on.**

CHECK : Is the power supply cable or connection plug disconnected?

ACTION : Connect it tightly.

CHECK : Is the fuse blown?

ACTION : Replace the fuse. If the fuse blows again, please send the entire product back to us for repair.

● **Pump does not operate.**

CHECK : Is the power supply cable or connection plug disconnected?

ACTION : Connect it tightly.

CHECK : Is the nozzle or hole in the heating element clogged?

ACTION : Clean it.

● **Solder is not being absorbed.**

CHECK : Is the heater tube or nozzle clogged?

ACTION : Clean it.

CHECK : Is the ceramic paper filter hardened?

ACTION : Replace it with a new one.

CHECK : Is there a vacuum leak?

ACTION : Check the connections and filter pipe seals and replace any worn parts.

● **The nozzle does not heat up.**

CHECK : Is the desoldering gun cord assembly properly connected?

ACTION : Connect it tightly.

CHECK : Is the heating element damaged?

ACTION : Replace it with a new one.

NOTE :

When repairs are needed, please send both the handpiece and the station to your sales agent.

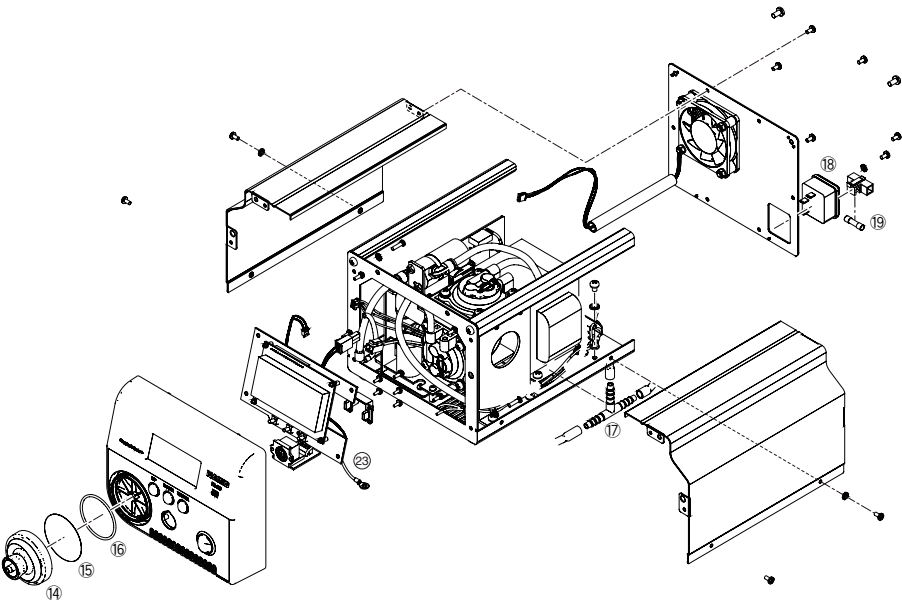
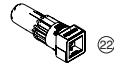
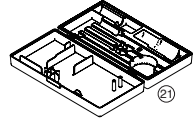
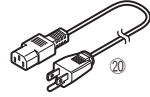
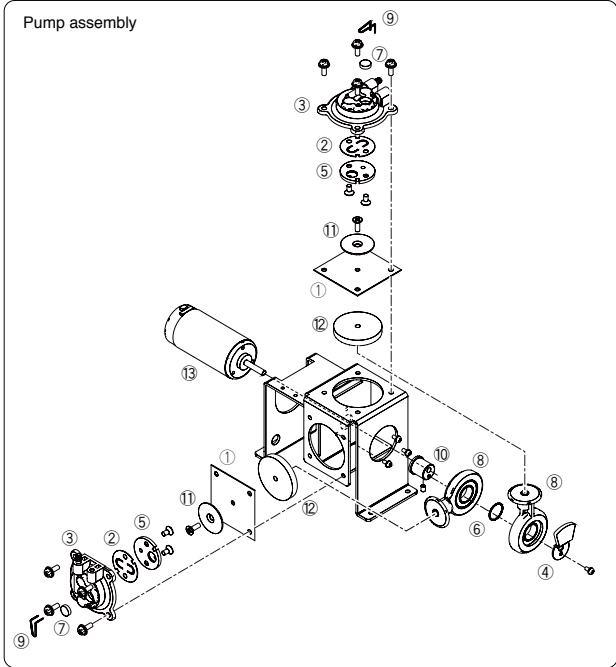

11. PARTS LIST



● HAKKO FR-400

Item No.	Part No.	Part Name	Specifications
①	A1013	Diaphragm	2 pcs.
②	A1014	Valve plate	2 pcs.
③	B1050	Pump head	
④	B1053	Balance weight	
⑤	B1056	Fixing plate	
⑥	B1057	Ring for bearing	
⑦	B1059	Exhaust filter	2 pcs.
⑧	B1312	Crank	
⑨	B1313	Filter retaining pin	
⑩	B2060	Crank shaft	
⑪	B2085	Diaphragm setting plate	
⑫	B2506	Damper	2 pcs.
⑬	B3428	Motor	
⑭	B5076	Vacuum outlet cap	
⑮	A5020	Filter	Set of 10
⑯	B5077	O-ring	for vacuum outlet retainer
⑰	B3414	Inner hose joint	
⑱	B2384	Inlet	
⑲	B3674	Fuse/250V-7A	100 - 120V
	B3675	Fuse/250V-4A	220 - 240V
⑳	B2419	Power cord, 3 wired cord & American plug	USA
	B2421	Power cord, 3 wired cord but no plug	220-240V
	B2422	Power cord, 3 wired cord & BS plug	India
	B2424	Power cord, 3 wired cord & European plug	220V KTL, 230V CE
	B2425	Power cord, 3 wired cord & BS plug CE	230V CE, U.K
	B2426	Power cord, 3 wired cord & Australian plug	
	B2436	Power cord, 3 wired cord & Chinese plug	China
	B3508	Power cord, 3 wired cord & American plug(B)	
	B3550	Power cord, 3 wired cord & SI plug	
㉑	C5011	Tool box	
㉒	B5082	Nozzle wrench	
㉓	B5090	P.W.B./for control	with LCD connector

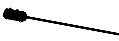
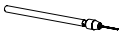
● Cleaning pin / Drill

	Part No.	Part Name	Specifications
	B1215	Cleaning pin	For heating element
	B1086	Cleaning pin	For ø0.8 mm (0.03 in.) nozzle
	B1087	Cleaning pin	For ø1.0 mm (0.04 in.) nozzle
	B1088	Cleaning pin	For ø1.3 mm (0.05 in.) nozzle
	B1089	Cleaning pin	For ø1.6 mm (0.06 in.) nozzle
	B1302	Cleaning drill	For ø0.8 mm (0.03 in.) nozzle
	B1303	Cleaning drill	For ø1.0 mm (0.04 in.) nozzle
	B1304	Cleaning drill	For ø1.3 mm (0.05 in.) nozzle
	B1305	Cleaning drill	For ø1.6 mm (0.06 in.) nozzle
	B1306	Drill holder	For ø0.8 mm (0.03 in.)/1.0 mm (0.04 in.) nozzle
	B1307	Drill holder	For ø1.3 mm (0.05 in.)/1.6 mm (0.06 in.) nozzle
	B1308	Drill bit	For ø0.8 mm (0.03 in.) nozzle (set of 10)
	B1309	Drill bit	For ø1.0 mm (0.04 in.) nozzle (set of 10)
	B1310	Drill bit	For ø1.3 mm (0.05 in.) nozzle (set of 10)
	B1311	Drill bit	For ø1.6 mm (0.06 in.) nozzle (set of 10)

● HAKKO FR-4003

Item No.	Part No.	Part Name	Specifications
①	A5017	Front holder	
②	B5080	Pre-filter	
③	A5018	Filter holder	
④	A5045	Ceramic paper filter	Set of 10
①-④	B5184	Filter pipe assembly	
⑤	B5221	Enclosure pipe	FR-4003
⑥	B5223	Joint cover	FR-4003
⑦	B5226	Wave spring	FR-4003
⑧	B5225	Movable joint	FR-4003
⑨	A5054	Heating element	FR-4003

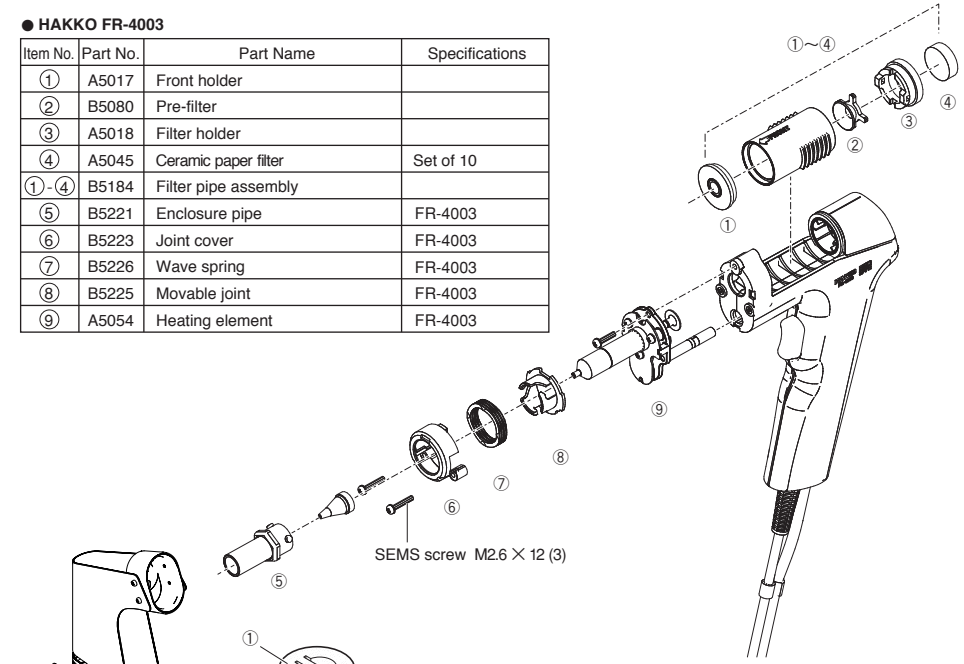

SEMS screw M2.6 X 12 (3)

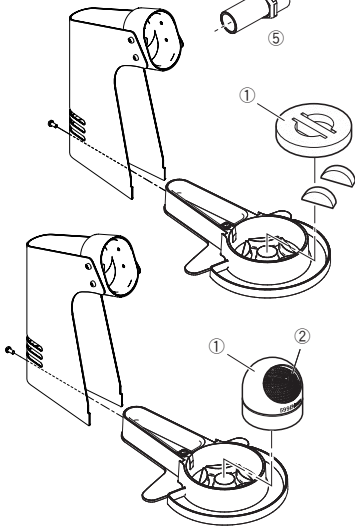

SEMS screw M3 x 12 (2)

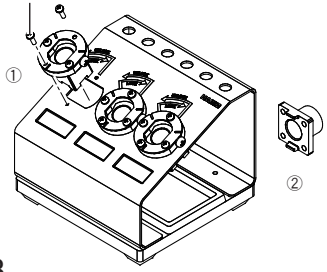

● Iron holder

Part No.	Part Name	Specifications
FH400-81	Iron holder	with cleaning sponge

● Iron holder parts

Item No.	Part No.	Part Name	Specifications
①	A1519	Cleaning sponge	

● Iron Holder

Part No.	Part Name	Specifications
FH400-82	Iron holder	with cleaning wire

● Iron Holder Parts

Item No.	Part No.	Part Name	Specifications
①	FT400-81	Tip cleaner	
②	599-029	Cleaning wire	

● Option (C5045)

Item No.	Part No.	Part Name	Specifications
①	B5227	Receptacle	with screw
②	B5229 ^{*1}	Oval nozzle positioning jig	for N60-08, 09

*1 If using N60-08, 09 oval nozzles, attach a oval nozzle positioning to the receptacle.

12. WIRING DIAGRAM

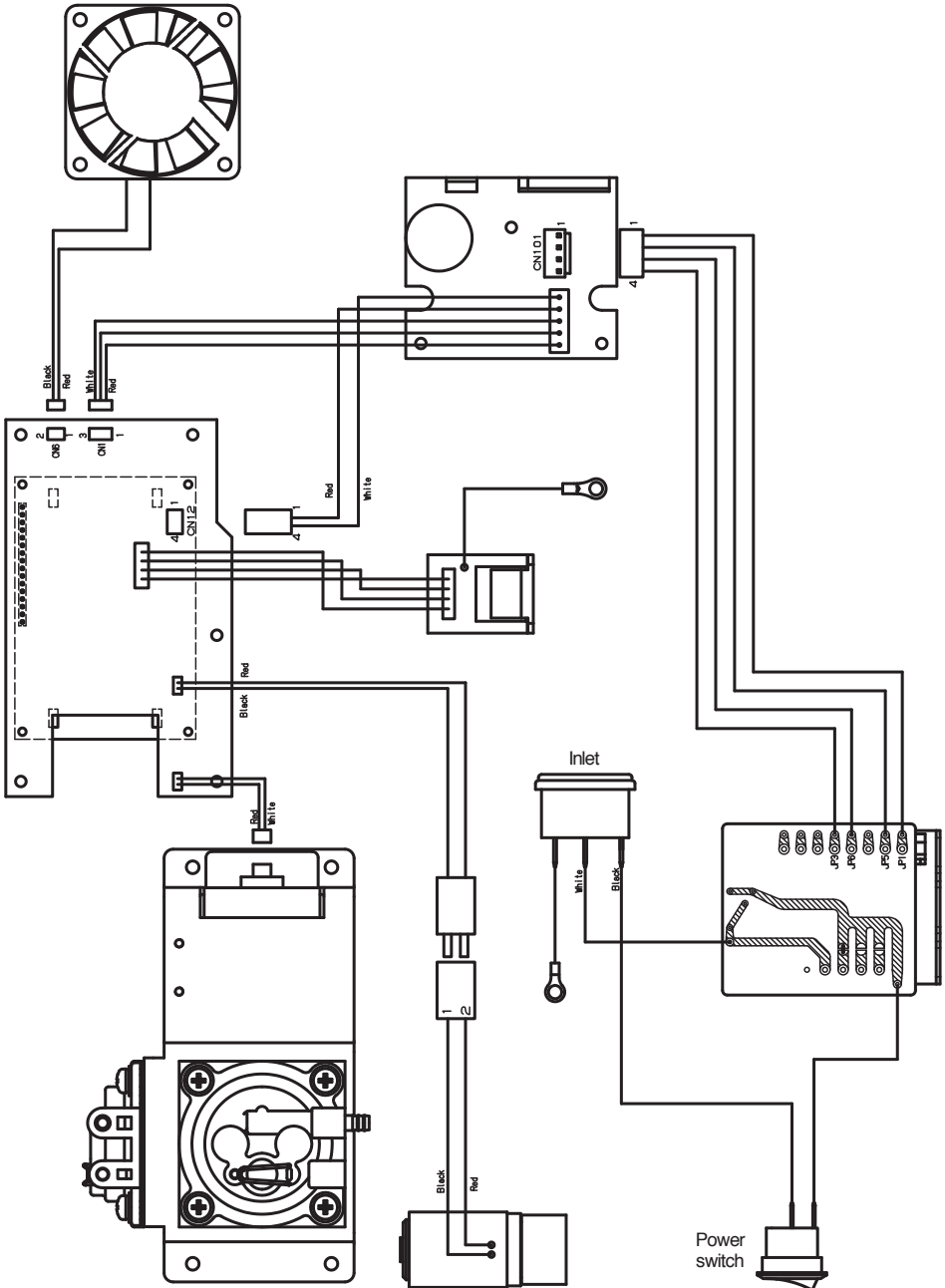



HAKKO CORPORATION

HEAD OFFICE

4-5, Shiokusa 2-chome, Naniwa-ku, Osaka 556-0024 JAPAN

TEL:+81-6-6561-3225 FAX:+81-6-6561-8466

<http://www.hakko.com> E-mail:sales@hakko.com

OVERSEAS AFFILIATES

U.S.A.: AMERICAN HAKKO PRODUCTS, INC.

TEL: (661) 294-0090 FAX: (661) 294-0096

Toll Free (800)88-HAKKO

<http://www.hakkousa.com>

HONG KONG: HAKKO DEVELOPMENT CO., LTD.

TEL: 2811-5588 FAX: 2590-0217

<http://www.hakko.com.hk>

E-mail:info@hakko.com.hk

SINGAPORE: HAKKO PRODUCTS PTE LTD.

TEL: 6748-2277 FAX: 6744-0033

<http://www.hakko.com.sg>

E-mail:sales@hakko.com.sg

Please access to the following address for the other Sales affiliates.

<http://www.hakko.com>